

# QUENCHING TOWER WQ20-HP



## QUENCHING TOWER WQ20-HP

way for upgrading existing Quenching tower with reduction of dust emissions

For coke oven plants, emissions into the air are one of the most significant issue. With conventional wet coke quenching usually up to hundreds gram of dust are emitted into the atmosphere per ton of coke.

However present environmental requirements and BAT standards pose much more stringent demand for dust emission reduction.

Installation of quenching tower upgrade WQ20-HP is used for reduction of dust emissions from quenching tower into the air below BAT limits (20g/t quenched coke).

HUTNÍ PROJEKT Frýdek-Místek has developed the system for significant reduction of dust emissions from Quenching towers to the level < 20 g/t of quenched coke.

System consists in installation of secondary quenching circuit with patented inserts and installation of secondary spraying nozzles into existing Quenching tower as a supplement to the existing primary quenching system which remains. Both the existing primary quenching circuit and new secondary quenching system are gravitational and are working together.

Provided system enable to upgrade present Quenching tower with relatively low investment costs and short realization time in order to meet new environmental standards.



*Secondary quenching*

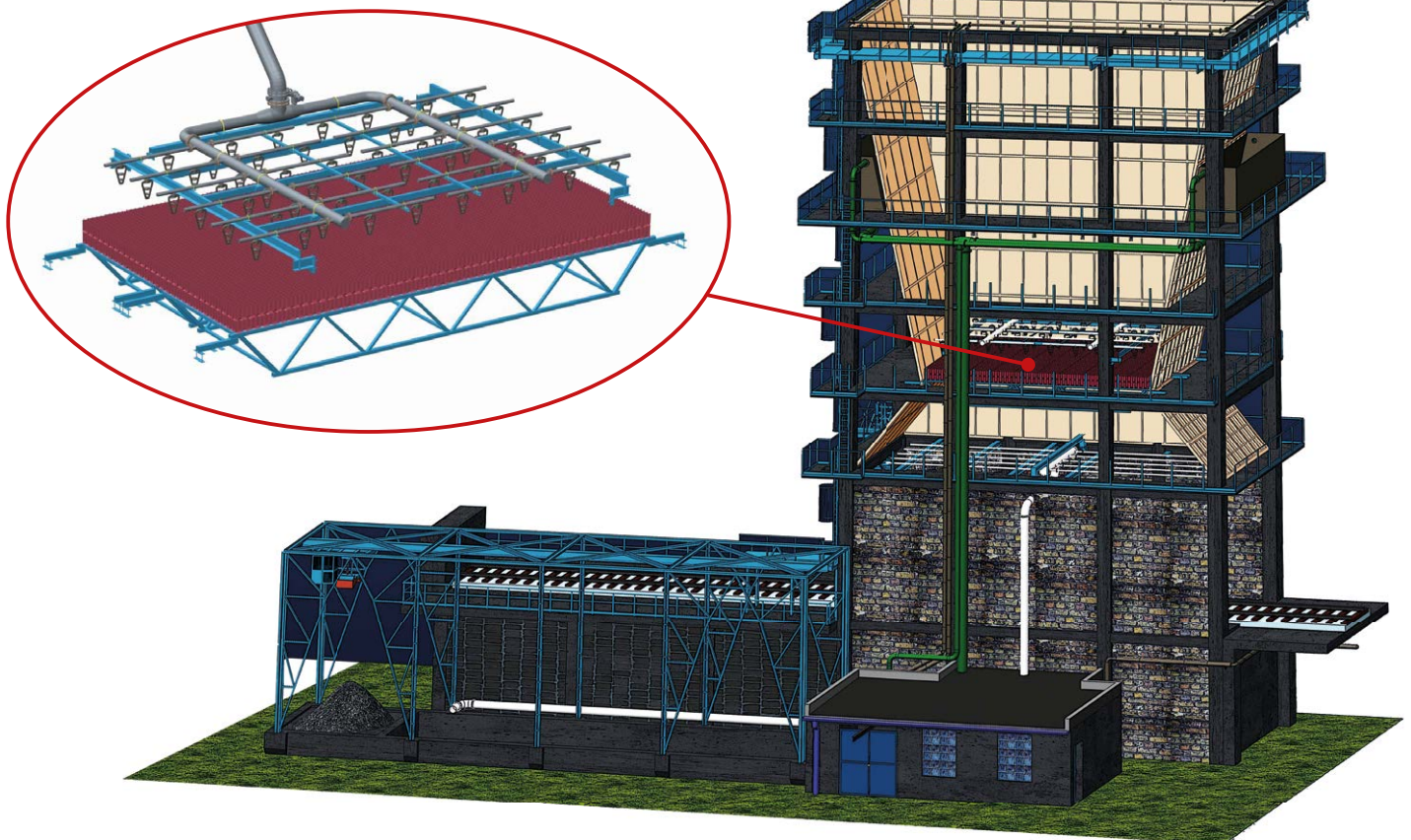

**Secondary quenching system:**

- 2 pcs of steel water tanks located on sides of Quenching tower (usually existing tanks)
- new inserts with supporting structure placed into Quenching tower above already existing quenching system
- special spray nozzles grid placed above inserts
- water distributing pipelines and valves
- control element

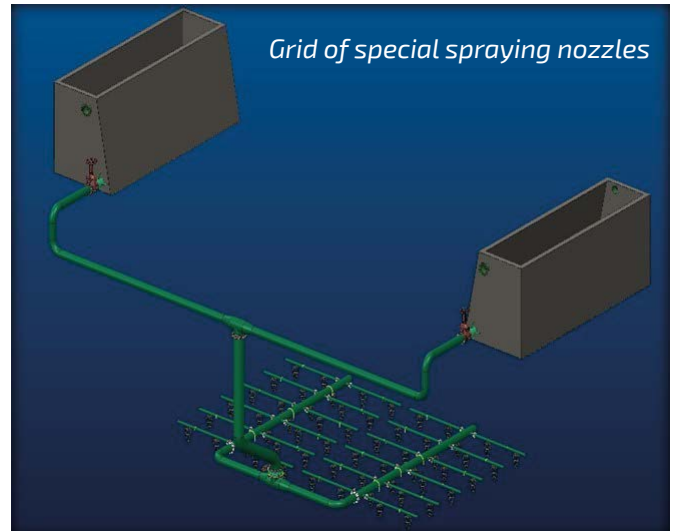
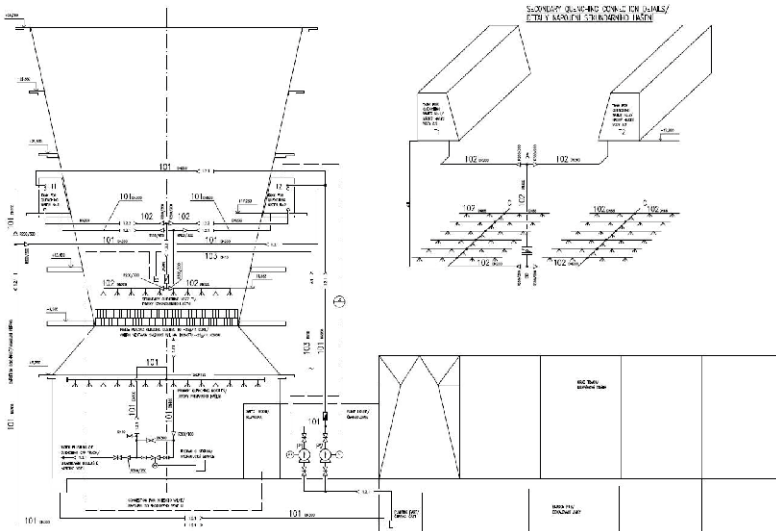

**Model and real design of inserts - cups**

In order to prevent dust particles to be created and released out of quenching tower, two layers of special inserts - “cups” are placed onto supporting structure into quenching tower.

These cups have defined shape and slot, defined dimensions and orientation which is based on mathematical model as well as practical tests.

Quenching water flows to the grid of special spraying nozzles situated approx. 800 mm above inserted two cup layers. This ensure equal water sprinkling to cups.

Water is retained in these cups during quenching and it serves as a filter. Implosion of water steam is concerned. Fine coke dust absorbed by quenching water falls down back to the coke on the quenching car.

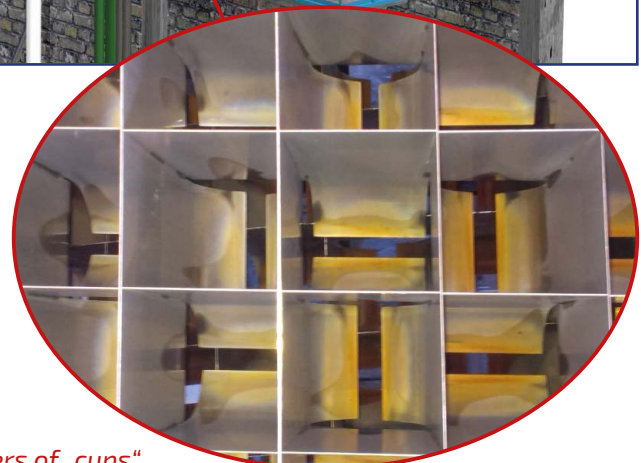
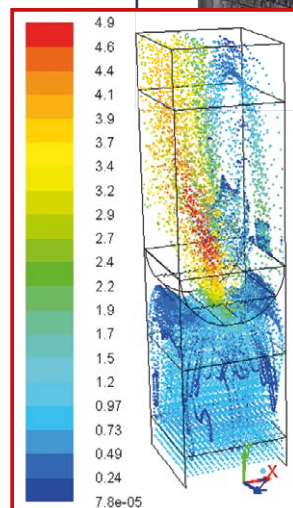
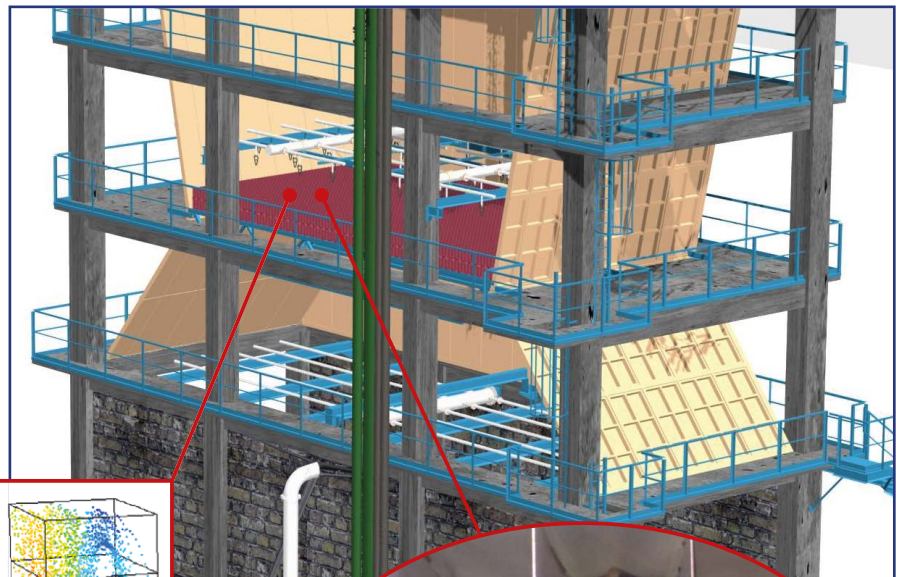

2 layers of „cups“

Inserts placed into Quenching tower decreases natural draft effect. Mathematical modelling and calculation of tower draft is provided for each specific quenching tower so as to check and ensure its proper functionality.

In case of necessity existing Quenching tower shall be increased to proper height in order to secure desired draft. New height of the tower is usually designed by the steel supporting superstructure with new timbering.

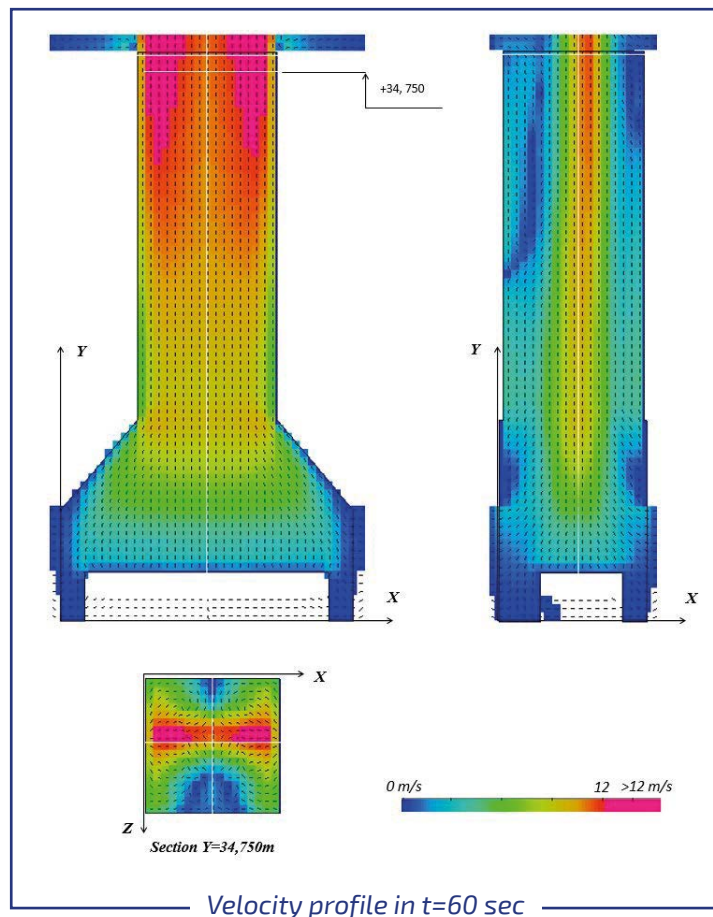
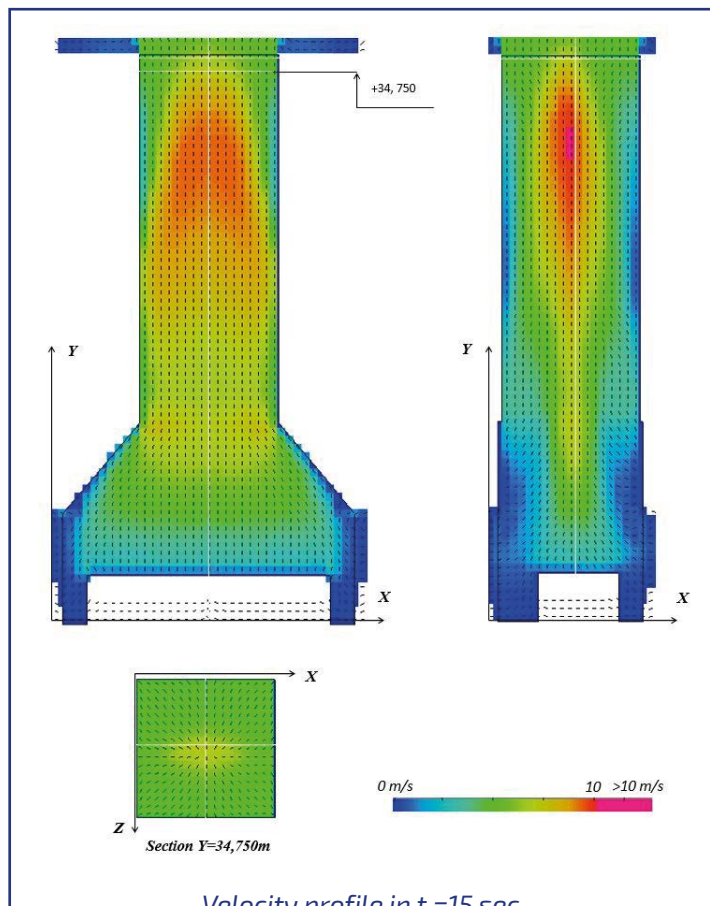

#### Main features:

- quenching dust emissions < 20 g/t of quenched coke, lower levels reachable
- both existing quenching (primary) system and newly implemented secondary quenching system are working together
- total amount of quenching water is not changed
- quenching time is not changed
- coke moisture – decreasing compare to present status
- additional load to Quenching tower – approx. 5-6 t
- Quenching tower draft modelling and calculation provided

Beside upgrade of existing Quenching tower HPFM provides on the same principle also designing and supply of new Quenching towers fulfilling latest environmental standards and BAT requirements.

#### CONTACT:

HUTNÍ PROJEKT Frýdek-Místek a.s.

28. října 1495

738 01 Frýdek-Místek

Czech Republic

Phone: +420 558 877 210

E-mail: [hpfm@hpfm.cz](mailto:hpfm@hpfm.cz)

[www.hpfm.cz](http://www.hpfm.cz) / [www.hutniczech.com](http://www.hutniczech.com)